

## Strain-stress analysis of lower limb with applied fixator

M. Mrázek<sup>a,\*</sup>, Z. Florian<sup>a</sup>, R. Veselý<sup>b</sup>, L. Borák<sup>a</sup>

<sup>a</sup>*Institute of Solid Mechanics, Mechatronics and Biomechanics, Faculty of Mechanical Engineering, Brno University of Technology, Technická 2896/2, 616 69 Brno, Czech Republic*

<sup>b</sup>*Trauma Hospital of Brno, Ponávka 6, 662 50 Brno, Czech Republic*

Received 27 August 2009; received in revised form 19 May 2010

---

### Abstract

This paper compares physiological state of tibia before and after application of an external fixator. The fixator systems' models but also model of tibia are loaded in the direction of body axis. The paper is focused on the examination of differences in stiffness before and after the application of fixation. Two types of axial external fixators are compared. Both fixators differ in their construction. The first fixator is two-frame and fixation rods are used for fixing the bone tissue (variant I). The second one is fixed into tibia with screws (variant II). We have found out that the two-frame external fixator has much bigger stiffness during limb fixation than the fixator with one body. Much higher deformations compared to physiological state of tibia occur in the variant II.

© 2010 University of West Bohemia. All rights reserved.

*Keywords:* strain-stress analysis, external fixation, tibia

---

### 1. Introduction

People face during their life different crisis situations. Man's birth is one of this situation. Fracture of virtual arbitrary bone can occur during a childbirth regarding forces acting on a child. Fractures of clavicle, humerus and femur happen in most cases. It can cause shortening of a limb during the first days after birth with subsequent complications during the life. Therefore this injury is healed by means of partial repositioning. Regarding the state of bone tissue in youth when there is strong ability of remodelling the fixation made like that is sufficient [3].

A different situation occurs in the elderly when biological processes of bone tissue recovery are slowing down. Also mechanical properties of bone tissue are changing.

The probability of an injury increases with active integration of a man into society. Life pace becomes faster and people try more often to overcome their limits. It often leads to complicated injuries including also fractures.

The fractures represent a state of bones when they malfunction as body support. We can distinguish two basic types of fractures – simple and complicated. There is no life threat in case of simple fractures. The treatment is based on adjustment of fractures and their fixation. These fractures are mostly cured using plaster bandage.

The treatment of complicated fractures is much more difficult. Bone tissue but also soft tissue injuries happen in most cases. Therefore the treatment of bone tissue but also soft tissue cover is necessary. That is why plaster bandage cannot be used for fracture fixation. Fixators are used to fixate the fractured bones in this case. Fixators are furthermore used in the treatment

---

\*Corresponding author. Tel.: +420 739 176 870, e-mail: mrazekmichal@gmail.com.

of limb imperfections where damaged area must be overbridged. The fixation has principal influence on quality of bone concretion.

The stiffness of a system fixator – bone should be the same as stiffness of single bone. The second criteria of fixator functionality is no overloading of bone tissue during the treatment.

Two types of the most often applied fixators have been studied in terms of suggestion from Trauma Hospital of Brno. Both fixators belong to the category of axial fixators (see Fig. 1). This paper is concerned with the study of stiffness of two systems fixator – bone via strain-stress analysis and their comparison with physiological state of bone.

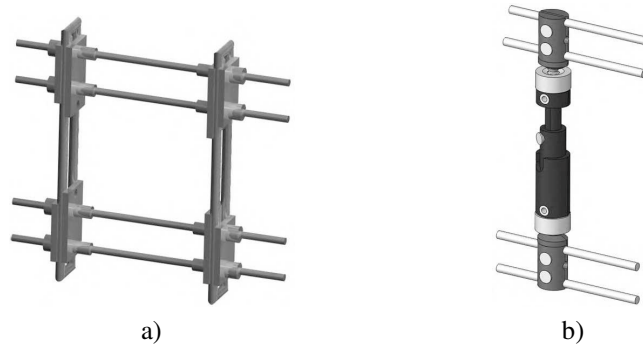

Fig. 1. Fixators: a) variant I, b) variant II

## 2. Solution methods

Regarding the nature of considered problem computational modelling is the most effective method.

### 2.1. Model of geometry

It is necessary to create appropriate models of geometry of system tibia – fixator and model of tibia in physiological state to solve the problem. The tibia model was obtained using 3D scanner ATOS I. The output of the scanner was a cloud of points that was processed via softwares Rhinoceros and SolidWorks. The thickness of tibia cortical tissue in different levels of the bone is the problem of our model. These values of thickness were obtained by measurements from the scanned model [5].

The tibia model consists of three components. The first one is cortical bone tissue and the two other components are cancellous bone tissue in condyles and in the body of tibia. Single areas of tibia differ in material characteristics which is necessary to include in model of geometry. A scheme of tibia with description of single components is shown in Fig. 2.

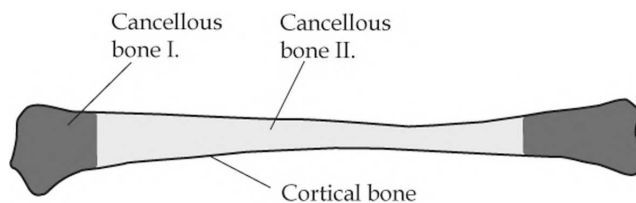

Fig. 2. Structure of tibia

The fixator denoted as variant I is an external axial fixator. Its model was created in software SolidWorks and it was converted into Ansys through SAT format. This fixator model consists of supporting frame and fixation rods passing through the tibia. This type of fixator is made from steel. Single components of fixator are firmly connected. A movement can occur only between bone and fixation rod.

The fixator denoted as variant II is a one-sided fixator and uses screws for fixation. There are more possibilities in slackening of heads placed on knuckle bolts. The fixator body is made from titanium alloy. Fixator's screws and its other parts are made from steel.

Both fixators are modelled with maximum possible configuration. Location of the fixators were chosen with respect to the limb structure [7].

## *2.2. FEM models*

Computing system ANSYS 11.0 (Ansys Inc., Canonsburg, PA, USA) was used for the computational modelling [1]. The element SOLID 95 with quadratic base function was chosen to discretize the model's volumes. This element is defined by 20 nodes having three degrees of freedom per node: translations in the nodal  $x$ ,  $y$ , and  $z$  directions. It may have any spatial orientation. Therefore, it enables better description of the geometry with complicated shape as in the case of a tibial model. The meshing largely consisted of regular hexahedral variant of elements. Degenerate quadrilateral variant of the element was used in the boundary. Contact elements CONTA174 and TARGE170 were used to model contact of two bodies such as fixation rod with bone tissue. CONTA174 is used to represent pressure contact between 3-D target surface and a deformable surface, defined by this element. The element is applicable to 3-D structural and coupled field contact analyses. It has the same geometric characteristics as the solid element face with which it is connected. The element is defined by eight nodes but it can degenerate to a six node element depending on the shape of the underlying solid. TARGE170 represents various 3-D target surfaces for the associated contact elements. The contact elements themselves overlay the solid describing the boundary of a deformable body and are potentially in contact with the target surface. The algorithm Multi-point Constraints Approach (MPC) was used in case of a contact of two bodies fastened together without possibility of a relative movement (e.g. screwed or welded parts). It means that two or more volume parts are put together and they behave as one entity. The default Augmented Lagrange method was used for cases with possible relative slipping and separation.

## *2.3. Model of material*

Human body is a complex organism. Human tissues are characterized by inhomogeneity and anisotropic, nonlinear properties which are modelled with difficulty. Homogeneous, isotropic and linear elastic model of bone material was used based on recherche study of similar problems. The material properties of the model are mainly described by Young's modulus and Poisson's ratio.

The tibia consists of two basic bone tissues – cortical and cancellous [4]. From a mechanical point of view, the cortical bone tissue is characterized by much higher stiffness than cancellous tissue.

The cancellous bone tissue reminds spongy structure. It can be found in the area of joints in case of long bones. There is much bigger amount of this tissue than in the area of diaphysis with only little amount of it.

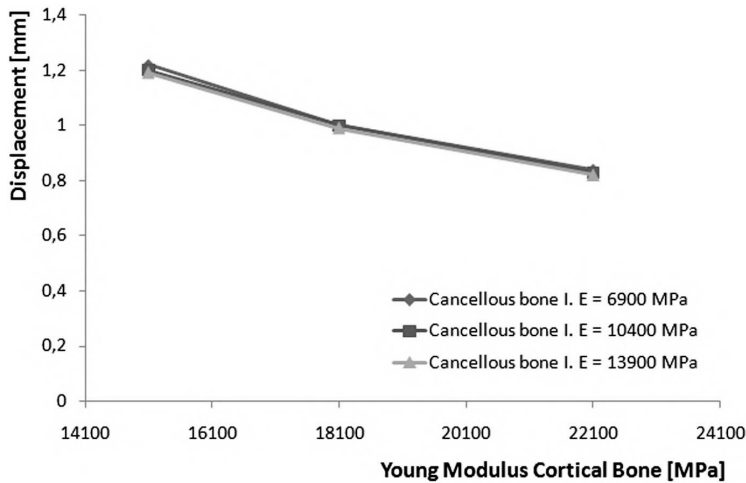

Fig. 3. Sensitivity analysis of tibia

Many variants of values can be found in literature. The Young's modulus of cortical bone tissue lies within the interval (15.1; 22.1) GPa while for cancellous bone tissue in the area of condyles it lies within the interval (6.9; 13.9) GPa [2].

The values of material characteristics are obtained on the basis of sensitivity analysis. We determine the influence of Young's modulus and Poisson's ratio on mechanical parameters (e. g. stiffness of bone tissue). The analysis was made for three values of Young's modulus of cortical bone tissue and three values of cancellous tissue Young's modulus. These values' ranges were given by the intervals mentioned above. The influence of Young's modulus of cortical and cancellous bone tissues on the total stiffness of tibia can be seen in Fig. 3. Stiffness of tibia is mostly influenced by changes of Young's modulus of cortical bone tissue. The biggest deformations occur with the smallest values of both Young's module. Therefore these smallest values within the given ranges were chosen for solving the problem. They describe the worst possible variants of bone tissues.

The amount of cancellous bone tissue is unsubstantial in the middle part of tibia on our distinguishing level. Therefore only cortical bone tissue is considered there. We used the following values of Young's module: for cortical bone tissue 15.1 GPa, for cancellous bone tissue I 6.9 GPa and for cancellous bone tissue II 0 GPa (for description of cancellous tissue variants see Fig. 2).

#### 2.4. Model of load and boundary conditions

If some of the bone tissue is missing and the fixator bridges the fracture, the patient must not load the affected limb. It means that he must use crutches for walking. Therefore, the limb with applied fixator can be loaded only by dead weight. Three most frequent load states were selected (see Fig. 4). The first state describes the situation when a patient lifts the limb in a hip from a horizontal position in the sagittal plane. The second state represents the limb hanging while walking with crutches. The third state describes the lifting of the limb in the frontal plane when a patient lies on his side and lifts the limb. A typical example in which all of these conditions occur is getting out of bed.

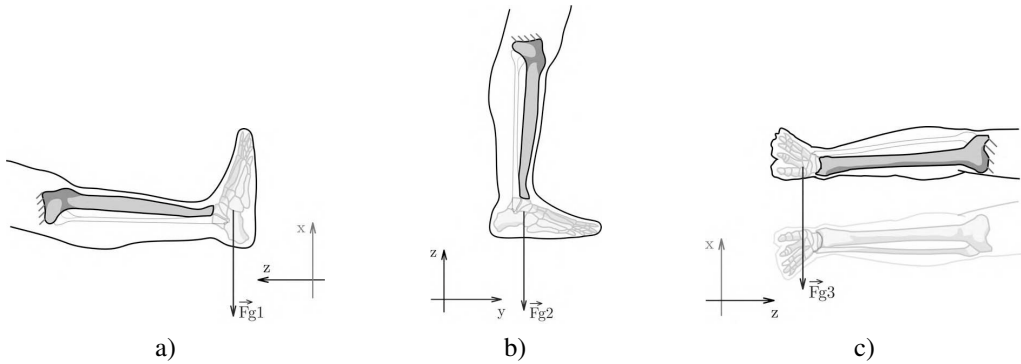

Fig. 4. Load states: a) 1, b) 2, c) 3

The tibia models (simple one and with applied fixators) have the same boundary conditions. All displacements are prevented in proximal condyle. This boundary condition simulates the moment when the knee joint is immobilized. The load is chosen on the basis of that the fixator must transfer half the weight of a calf and the whole weight of a sole which is 3 560 g [6]. The load acts on a sole at a distance 473 mm from the proximal condyle. In case of the second load state it corresponds to the load of 35.6 N acting vertically. If the limb is oriented horizontal to the ground (load states 1 and 3) the load is 27 N and differs only in orientation.

### 3. Analysis of results

#### 3.1. Evaluation of deformation of tibia and tibia with applied fixator

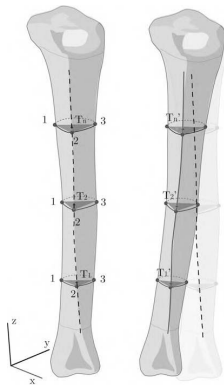

Fig. 5. Evaluation method

The following algorithm was chosen to evaluate displacements that occur during limb loading. The tibia is divided into horizontal slices by 1mm. Three nodes are selected on each slice and the displacements  $U_x$ ,  $U_y$  and  $U_z$  in the directions  $x$ ,  $y$  and  $z$  are determined. These displacements correspond to the direction of load. The evaluation algorithm is described for the displacements  $U_x$ . First of all, the displacements are evaluated in the nodes 1, 2, 3. These nodes represent the vertices of a triangle. Then the position of the centroid of the triangle is computed. A change in this position represents an interpolated displacement of the tibial cross-section in given slice in the  $x$ -axis. If all the slices are evaluated a curve representing the displacements in the  $x$ -axis is obtained. The same principle is used for the remaining axes. Fig. 5 shows the aforementioned evaluation method where the curves represent the values of displacement of bone tissue in different slices.

The stress distribution in different variants of fixation is represented by the first main stress  $S1$  that corresponds to the tensile stress and by the third main stress  $S3$  corresponding to the compression stress.

### 3.2. Physiological state of tibia

The physiological state of the tibia without applied fixator is analysed.

#### 3.2.1. Load state 1

The displacements  $U_x$ ,  $U_y$  and  $U_z$  of the tibia in axis  $x$ ,  $y$  and  $z$  are shown in Fig. 6a). The biggest displacements of the bone tissue occur in the direction of  $y$ -axis where the maximum value is  $-1$  mm. There are also displacements in the direction of  $x$ -axis with the maximum value  $0.4$  mm. The maximum value of the first principal stress is  $4.7$  MPa and occurs on the inner side of the tibia. The maximum value of the third principal stress is  $-5.6$  MPa which represents the compression stress on the back side of the tibia. The both principal stresses distribution is presented in Fig. 6b).

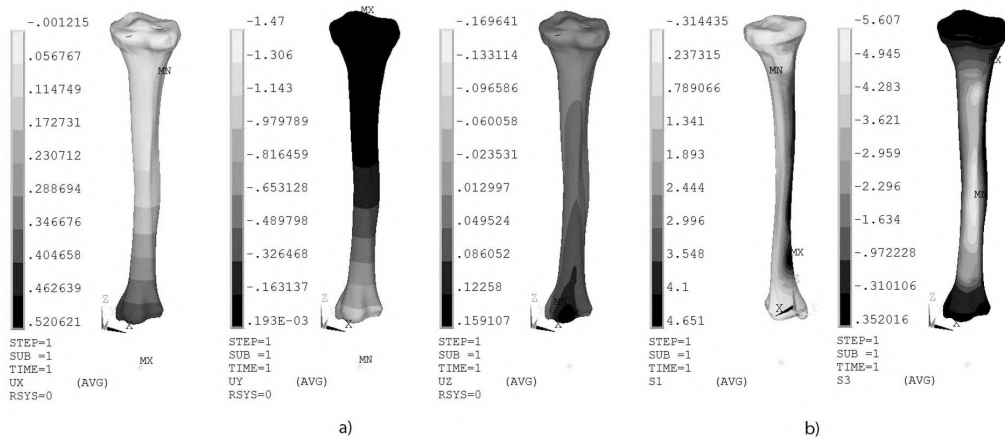

Fig. 6. Physiological state: a) The displacements, b) The first and third principal stress – load state 1

#### 3.2.2. Load state 2

The tibia is loaded by the dead weight of the limb when a patient leans on the crutches and there is no contact of the limb with a floor. The displacements (see Fig. 7a)) are so small that they are unsubstantial on the distinguishing level of the model. The maximum value of the first principal stress is  $0.5$  MPa (see Fig. 7b)).

#### 3.2.3. Load state 3

If the limb is loaded in the frontal plane there are also dominant displacements. The maximum value of the displacement is  $-1.2$  mm in the  $x$ -axis. There are also displacements in the  $y$ -axis with maximum value  $0.4$  mm (see Fig. 8a)). The displacements are qualitatively the same as in the case of the load state 1 and they are presented in Fig. 9. The maximum value of the first principal stress is  $6.4$  MPa in the transition point from epiphysis to diaphysis. The third principal stress reaches the maximum value of  $-5.6$  MPa. Distribution of the both principal stresses is presented in Fig. 8b).

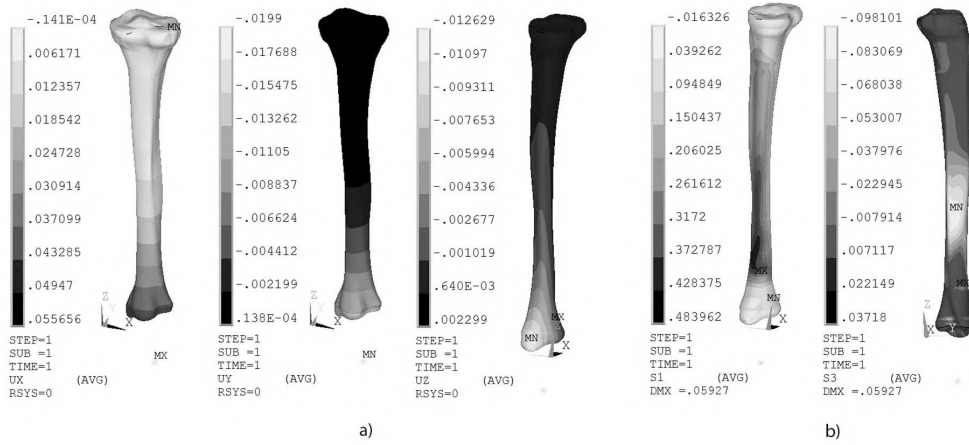

Fig. 7. Physiological state: a) The displacements, b) The first and third principal stress – load state 2

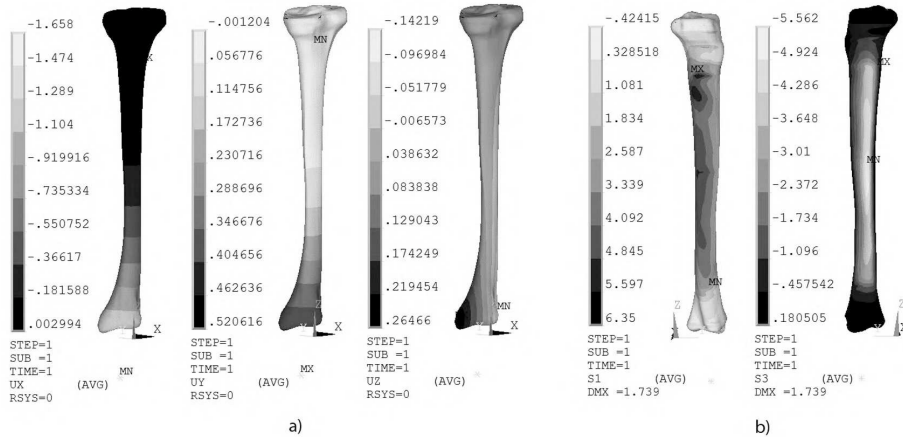

Fig. 8. Physiological state: a) The displacements, b) The first and third principal stress – load state 3

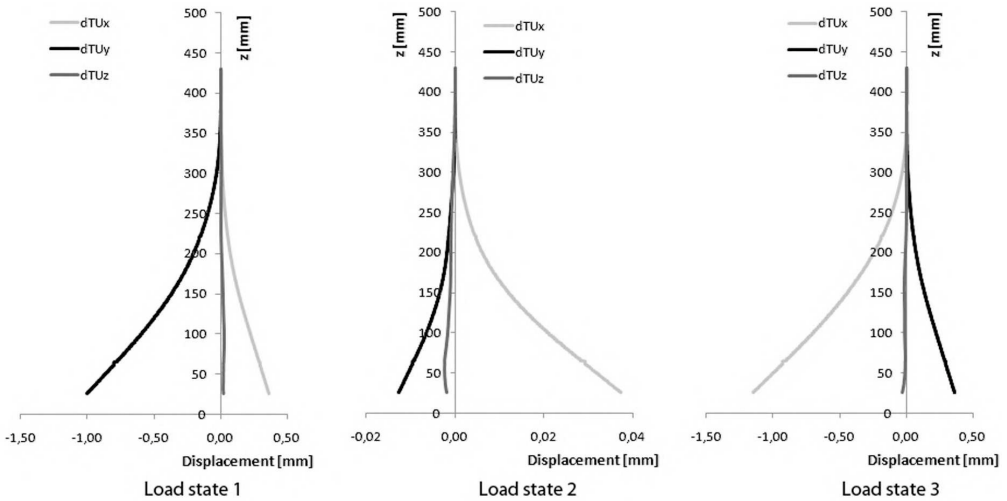

Fig. 9. Physiological state: Comparison of the displacements  $U_x$ ,  $U_y$  and  $U_z$

### 3.3. Variant I

#### 3.3.1. Load state 1

The maximum interpolated displacement occurs in the  $y$ -axis where the displacement of the distal condyle  $-2.9$  mm (see Fig. 10a)). The displacements in the opposite direction with respect to the physiological state occur in the  $x$ -axis where the maximum value is  $-0.7$  mm. The maximum value of the first principal stress is 201 MPa and it occurs in the area where the first rod enters the bone tissue. The third principal stress reaches its maximum of  $-127$  MPa also near the first rod. The first principal stress takes the values from 0 to 5 MPa while the third principal stress reaches the values from  $-6$  to 0 MPa in the bone tissue excepting the aforementioned neighbourhood of the first fixation rod. The maximum value of the reduced stress (HMH) on the fixator body is 130 MPa (see Fig. 10b)).

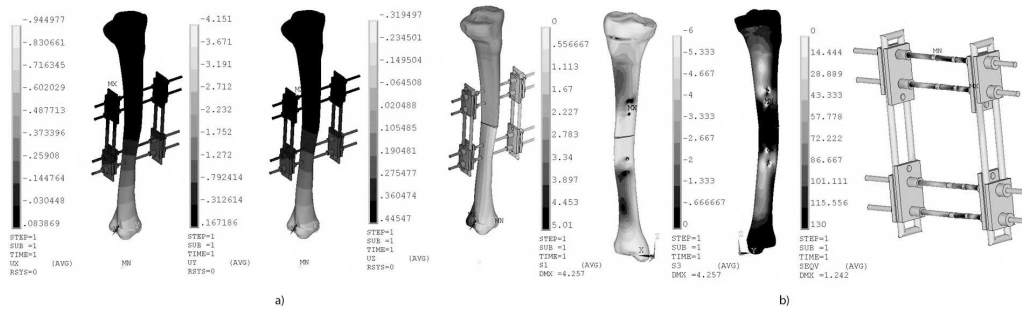

Fig. 10. Variant I: a) The displacements, b) The first and third principal stress – load state 1

#### 3.3.2. Load state 2

The maximum displacement of only 0.1 mm occurs in the  $x$ -axis. The other displacements are so small that they are unsubstantial on the distinguishing level of the model (see Fig. 11a)). The first and third principal stress reach their maximum in the area where the first rod enters the bone tissue (see Fig. 11b)). The maximum value of the first principal stress is 33 MPa and the maximum value of the third principal stress is  $-11$  MPa. Excepting the aforementioned neighbourhood of the first fixation rod, the first principal stress reaches the value 0.5 MPa. The maximum value of the reduced stress on the fixator body is 15 MPa.

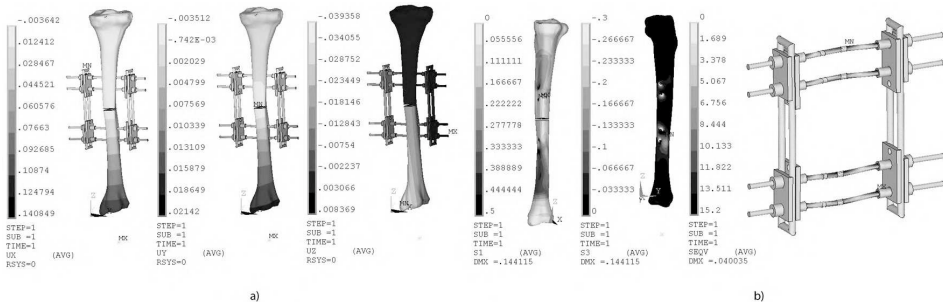

Fig. 11. Variant I: a) The displacements, b) The first and third principal stress – load state 2



### 3.3.3. Load state 3

The maximum displacement of  $-2.1$  mm occurs in the  $x$ -axis (see Fig. 12a)). The displacements in the opposite direction with respect to the physiological state occur in the  $y$ -axis where the maximum value is  $0.7$  mm (see Fig. 13). The third principal stress has a maximum value equal to  $225$  MPa and it occurs in a neighbourhood of the first rod. The third principal stress reaches its maximum of  $-127$  MPa also near the first rod. The first principal stress takes the values from  $0$  to  $7$  MPa while the third principal stress reaches the values from  $-7$  to  $0$  MPa in the bone tissue excepting the aforementioned neighbourhood of the first fixation rod (see Fig. 12b)).

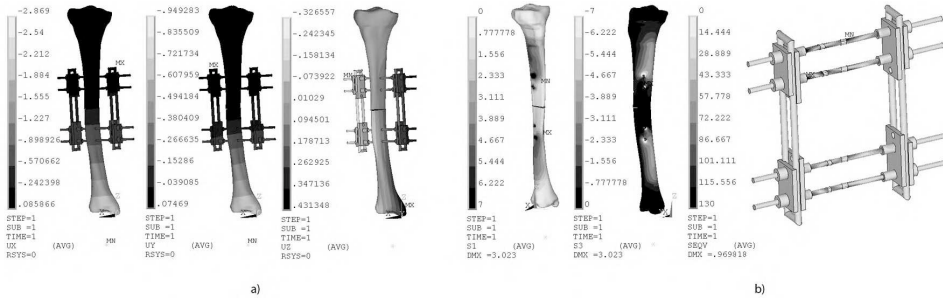

Fig. 12. Variant I: a) The displacements, b) The first and third principal stress – load state 3

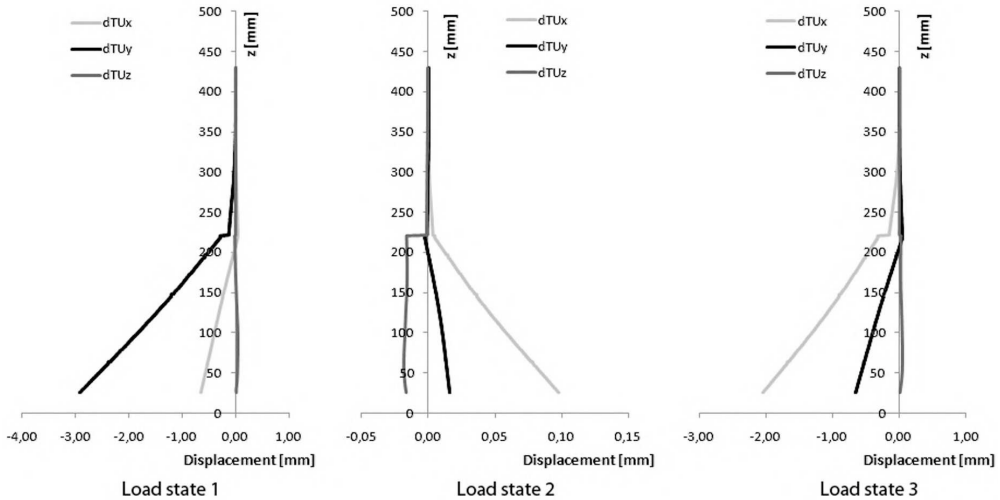

Fig. 13. Variant I: Comparison of the displacements  $U_x$ ,  $U_y$  and  $U_z$

## 3.4. Variant II

### 3.4.1. Load state 1

The maximum interpolated displacement occurs in the  $y$ -axis where the displacement of the distal condyle  $-1.7$  mm (see Fig. 17). Significant displacement with respect to the physiological state occurs in the  $z$ -axis with the maximum value of  $0.4$  mm (see Fig. 14a)). Twisting and

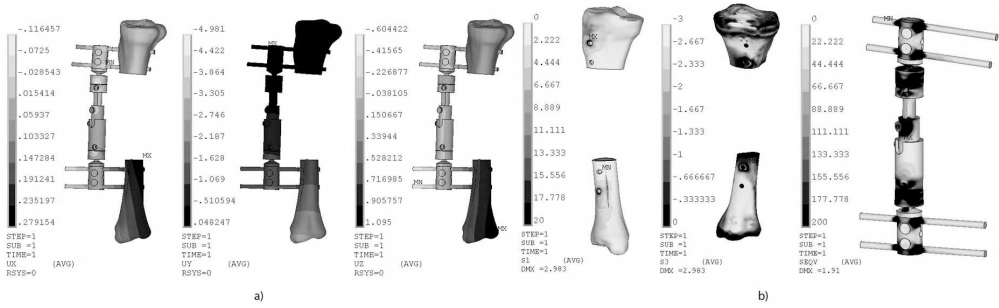

Fig. 14. Variant II: a) The displacements, b) The first and third principal stress – load state 1

bending of the fixator occur in this load state. The maximum value of the first principal stress in the bone tissue is 20 MPa and it occurs in the neighbourhood of the first fixation screw (see Fig. 14b)). The third principal stress reaches its maximum of  $-13$  MPa and it cumulates near the last screw.

### 3.4.2. Load state 2

The maximum displacement of 0.3 mm occurs in the  $y$ -axis. The maximum displacement of  $-0.1$  mm occurs in the  $z$ -axis on the distal condyle (see Fig. 15a)). The maximum value of the first principal stress in the bone tissue is 11 MPa. Excepting the maximum the first principal stress takes the values from 0 to 3 MPa. The third principal stress reaches its maximum of  $-10$  MPa while otherwise it takes the values from  $-1.5$  to 0 MPa (see Fig. 15b)).

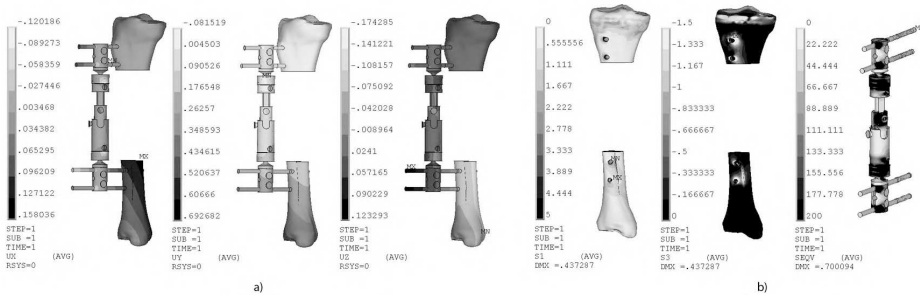

Fig. 15. Variant II: a) The displacements, b) The first and third principal stress – load state 2

### 3.4.3. Load state 3

The maximum displacement occurs on the distal condyle with the value of  $-3.2$  mm in the  $x$ -axis and  $-0.2$  mm in the  $z$ -axis (see Fig. 16a)). Twisting and bending of the fixator occur in this load state. The maximum value of the first principal stress in the bone tissue is 43 MPa and it occurs in the neighbourhood of the third fixation screw (see Fig. 16b)). The third principal stress reaches its maximum of  $-25$  MPa and it cumulates near the first screw.

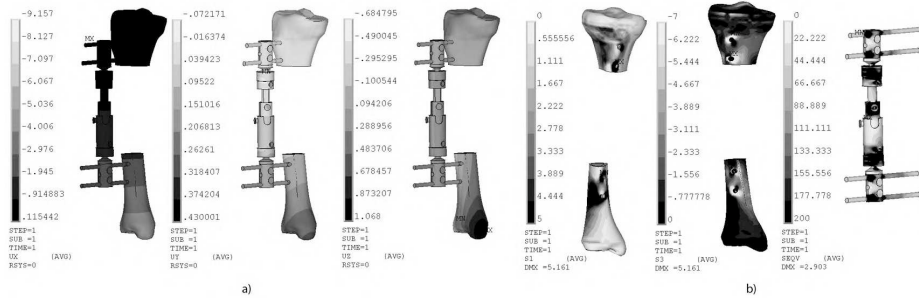

Fig. 16. Variant II: a) The displacements, b) The first and third principal stress – load state 3

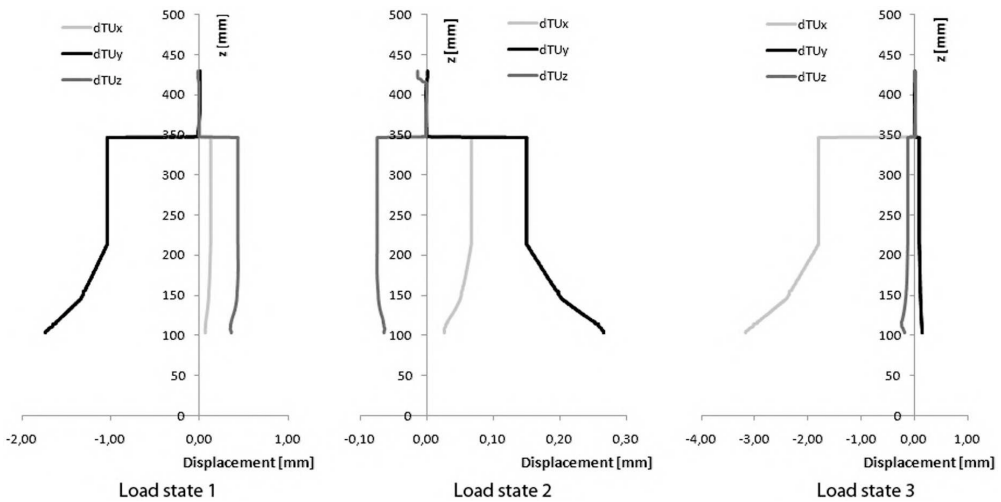

Fig. 17. Variant II: Comparison of the displacements  $U_x$ ,  $U_y$  and  $U_z$

#### 4. Conclusion

On the basis of the three load states analysis of the physiological state of tibia and state of tibia with applied fixators of variant I and II we can conclude as follows.

In the first stage of healing when some of the bone is missing, it is necessary for proper function of fixator to allow a stable connection of both parts of the bone fragments. The bone tissue must not be externally overloaded during the treatment to avoid necrotizing of the bone tissue. The distribution of the principal stresses in the bone tissue at least in the unaffected parts of the bone should be similar as in the physiological state. This is partially satisfied in the variant I. The displacements in the tibia are another indicator of suitability of fixation. The results of the variant I correspond well with this requirement.

The displacements in physiological state of tibia are smaller than in both cases of fixation. The displacements in case of fixator of variant I are qualitatively the same as in case of the physiological state. There is more rapid displacement increase in all directions in the distal part of the tibia in case of variant II. Furthermore, the fixator is bending as well as twisting during loading. During loading in the sagittal plane smaller displacement occur in the  $x$ -axis in load

state 1 in case of variant II than in case of variant I. But there are larger displacements in the direction of load on the distal condyle in case of variant II.

The first and third principal stresses reach the same values in the physiological state as well as in the states with applied fixators in the areas except the fixation rods or screws. The fixation rods and screws influence the bone tissue and overloading can occur there. The smallest stress in the area of screws occurs in load state 2. There is only tensile stress in the bone tissue in case of variant I. But in case of variant II the bending load instead of the tensile load happens. It means that the bone tissue must transfer the combination of tension and pressure. The bending load of the bone tissue occurs always in load states 1 and 3. Much higher stress is in the neighbourhood of the fixation rod, i.e. in variant I, than near the fixation screw, i.e. in variant II.

### **Acknowledgements**

This work was supported by the project from MSMT of the Czech Republic no. 2E08017 Procedures and Methods to Increase Number of Researchers.

### **References**

- [1] ANSYS Help, SAS IP, Inc., 2009.
- [2] Cowin, C. S., Bone Mechanics Handbook, CRC Press, Florida, 2001.
- [3] Doležal, A., Porodnické operace (Obstetric operations), Grada, Praha, 2007.
- [4] Marieb, N. E., Mallat, J., Anatomie lidského těla (Anatomy of the human body), CP Books, Brno, 2005.
- [5] Mrázek, M., Zampachova, E., Borak, L., Marcian, P., Strain-Stress Analysis Of Tibia, Proceedings of the 11th International Conference Applied Mechanics, Smolenice, FX, 2009, pp. 229–237.
- [6] Man-Systems Integration Standards (Volume I, Section 3): Antropometry and Biomechanics. <http://msis.jsc.nasa.gov/sections/section03.htm> [cited 13. 1. 2010]
- [7] Solomin, N. L., The Basic Principles of External Fixation Using the Ilizarov Device, Springer-Verlag, Italia, 2008.